

ACERO DE REFUERZO

MARCA	#	CANTIDAD	LONGITUD	DETALLE	UBICACION
A1	#6	4	325	Rectas	Aletones horizontales-ombos corras
A2	#4	16	320	Rectas	Aletones horizontales-ombos corras
A3 o A7	#4	2 c/u	82 o 285	Rectas	Aletones horizontales-ombos corras
A8 o A16	#4	2 c/u	139 o 285	Rectas	Aletones horizontales-ombos corras
A17	#6	4	494	A	Aletones inclinados-ombos corras
A18	#6	4	100	B	Aletones escuadrados-ombos corras
A19	#5	20	180	C	Flejes - Ganchos
F1	#6	66	224	Rectas	Fundación Transversales-orbe-abajo
F2	#6	18	394	Rectas	Fund. Longitudinales orbe, abajo
F3	#6	33	224	Rectas	Fund. Transversal entre pilotes
F4	#6	9	954	Rectas	Fund. Longitudinales entre pilotes
F5	#6	64	188	D	Doveles
M1	#6	2	960	Rectas	Pared de cabezal-horizonta/ ombe
M2	#5	50	169	Rectas	Pared de cabezal - vertical
M3	#5	16	187	Rectas	Pared de cabezal - vertical
M4	#5	8	960	Rectas	Pared de cabezal - horizontal
M5	#5	32	124	E	Pared de cabezal - ganchos
M6	#6	2	960	Rectas	Mensula - horizontal
M7	#4	32	118	F	Mensula estriadas
M8	#6	10	960	Rectas	Viga de cabezal - horizontal
M9	#4	32	326	G	Viga de cabezal - estriadas
M10	#4	24	130	H	Podestales-longitudinales
M11	#4	24	130	H	Podestales-Transversales

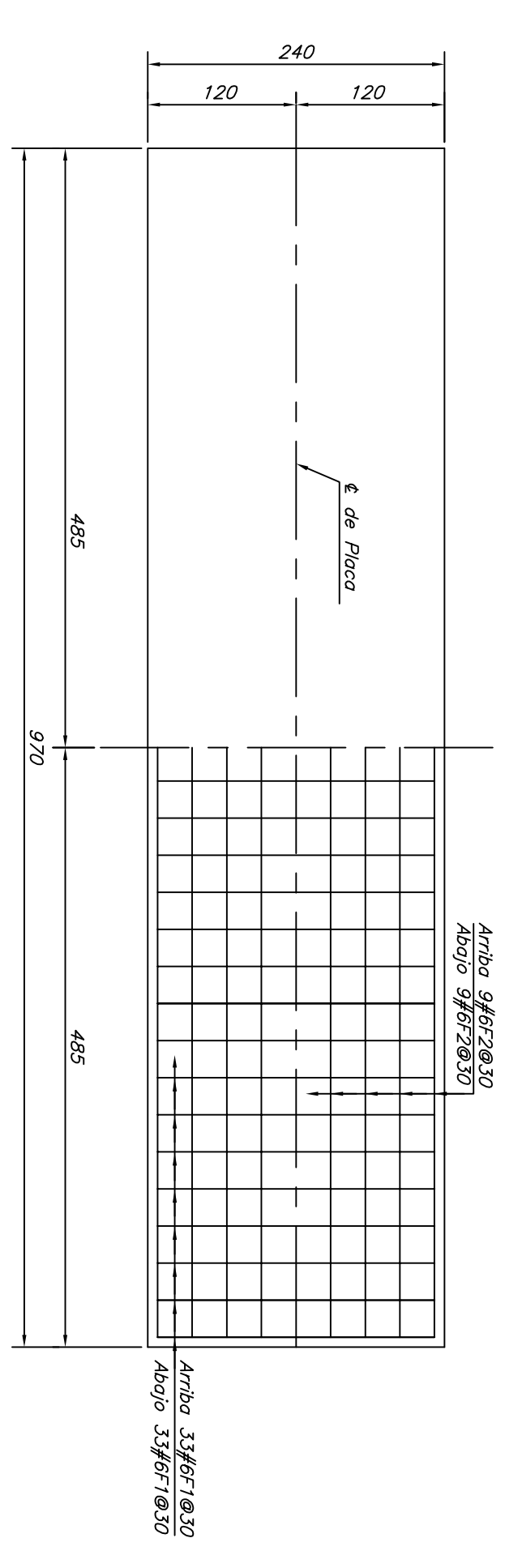

CARGA VIVA: HS 20+25% A.A.S.H.T.O.

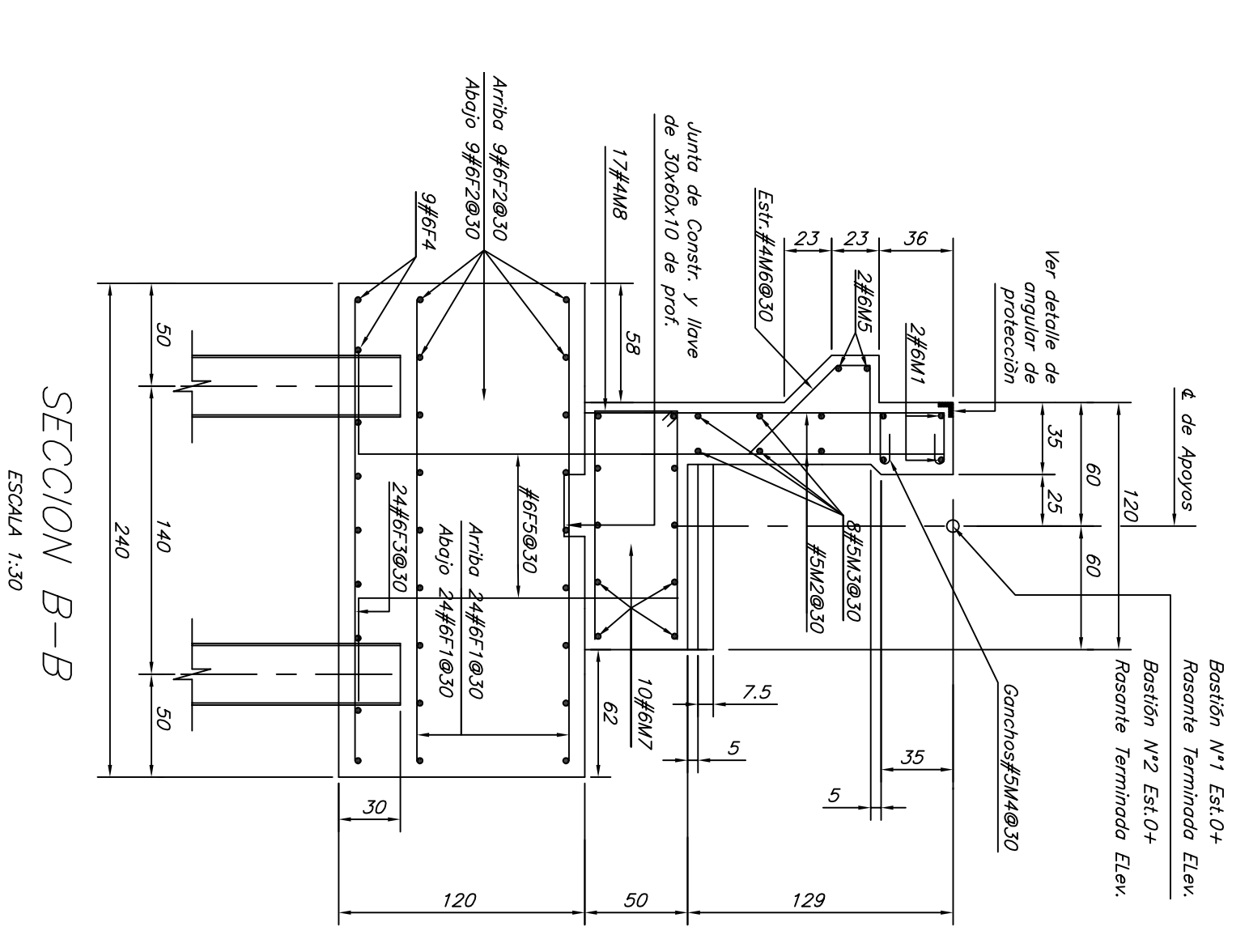
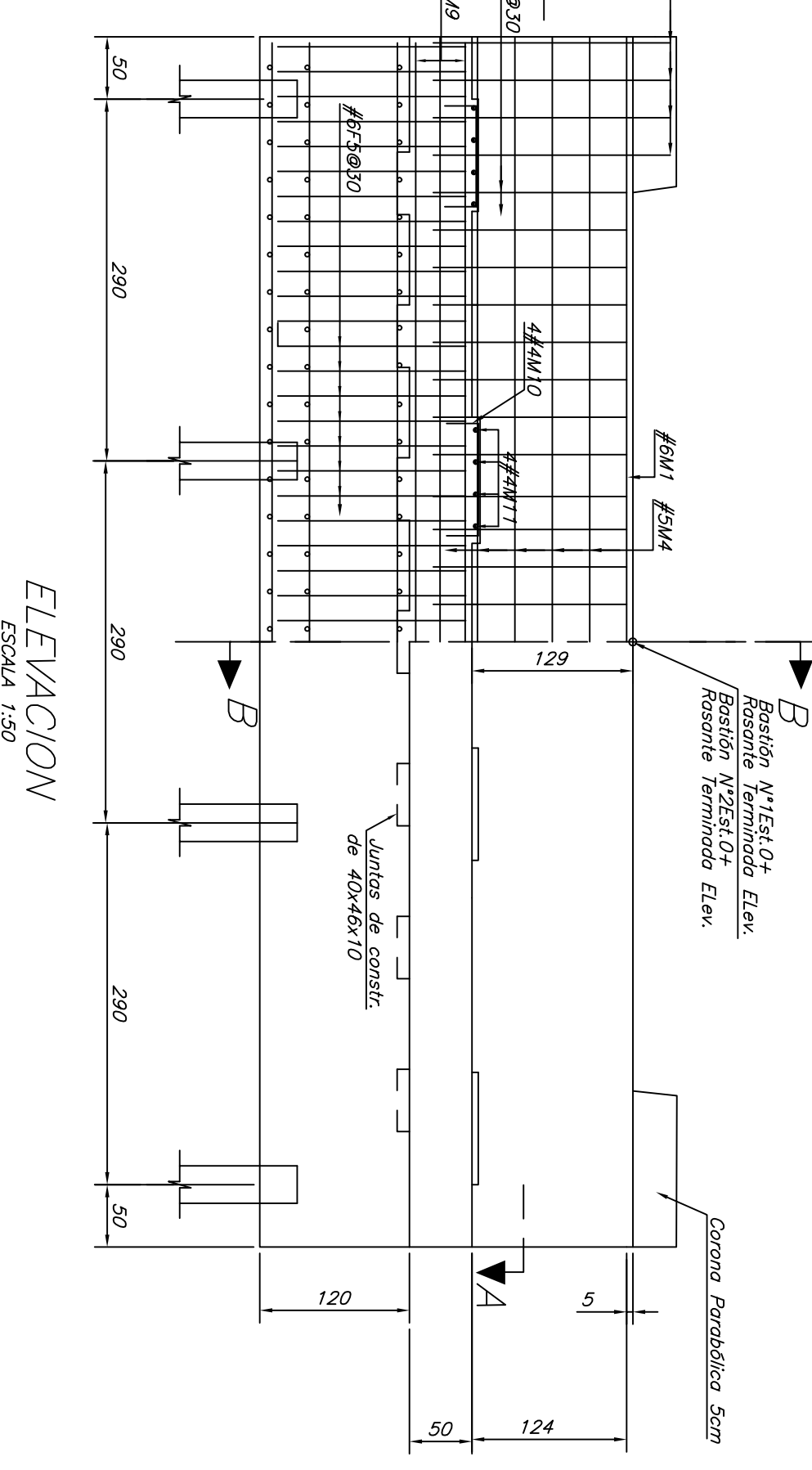
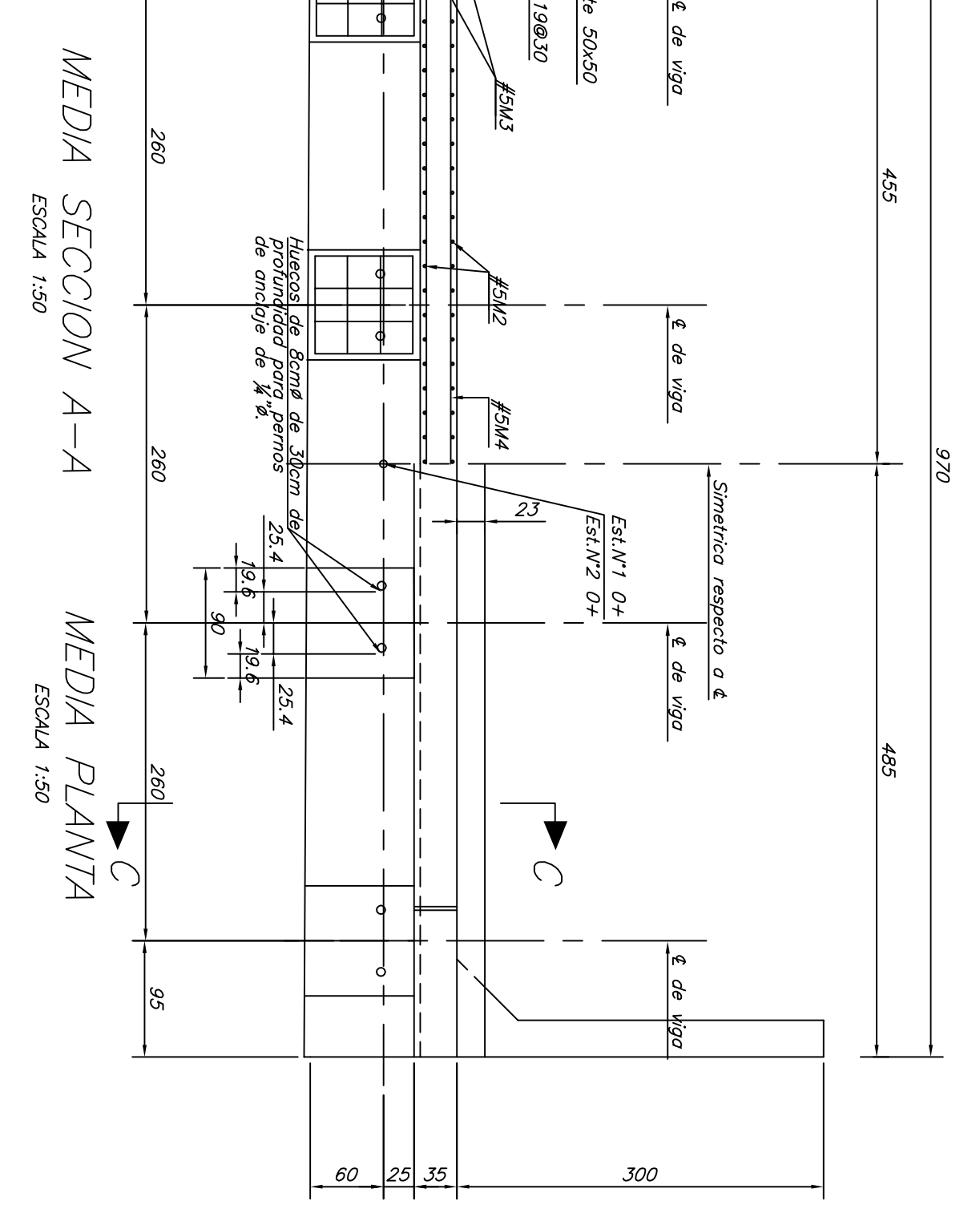
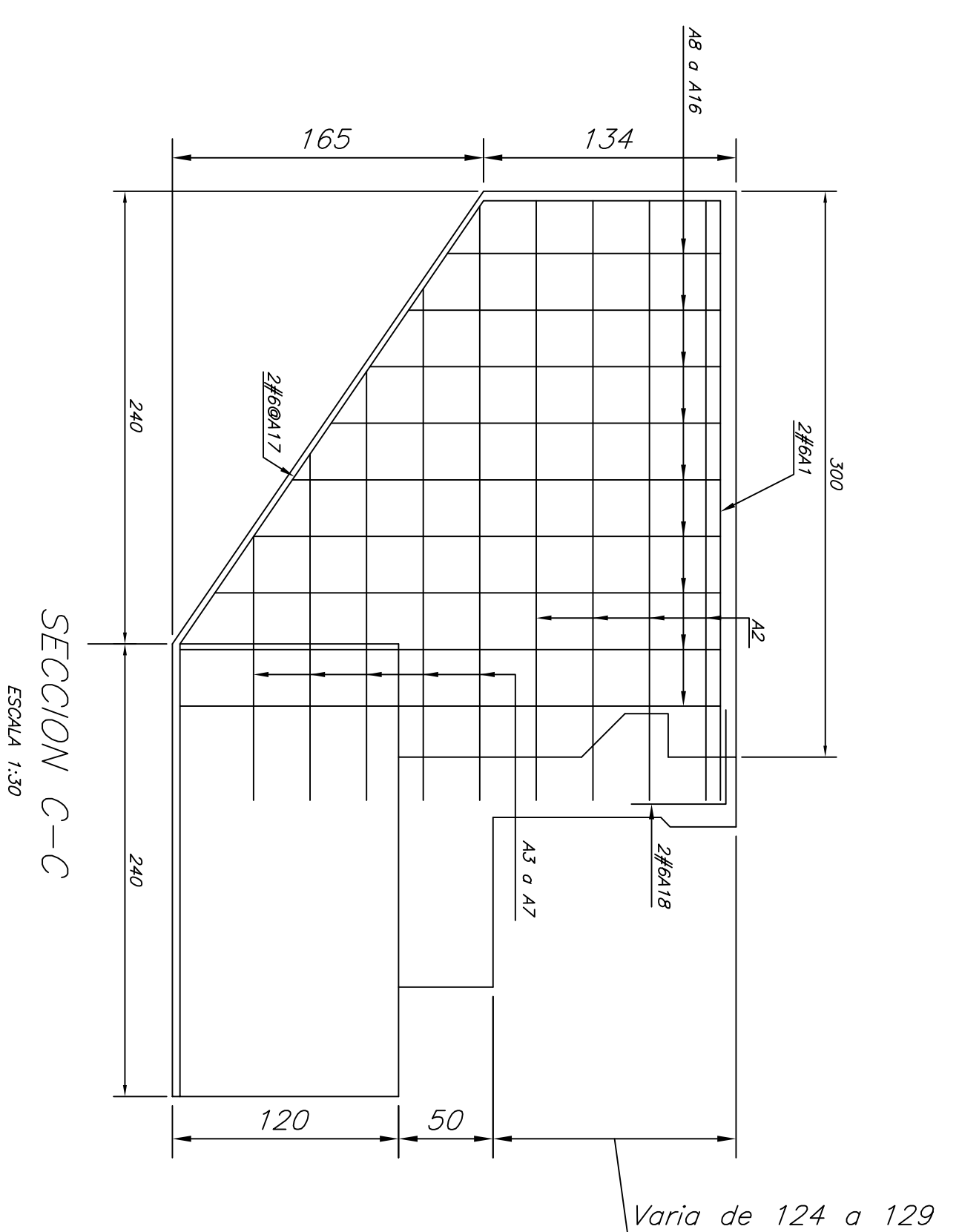
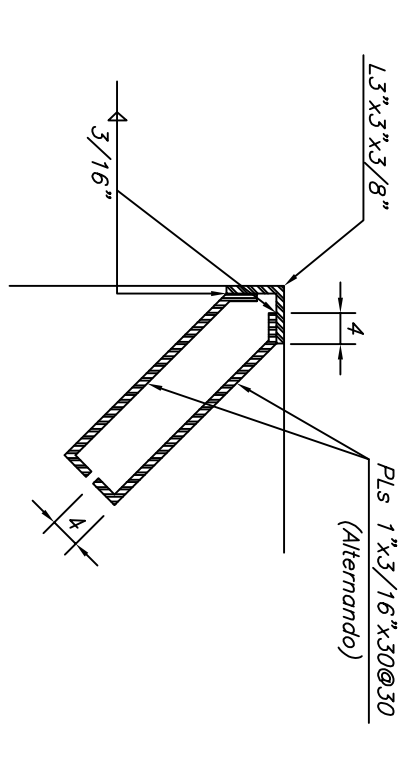
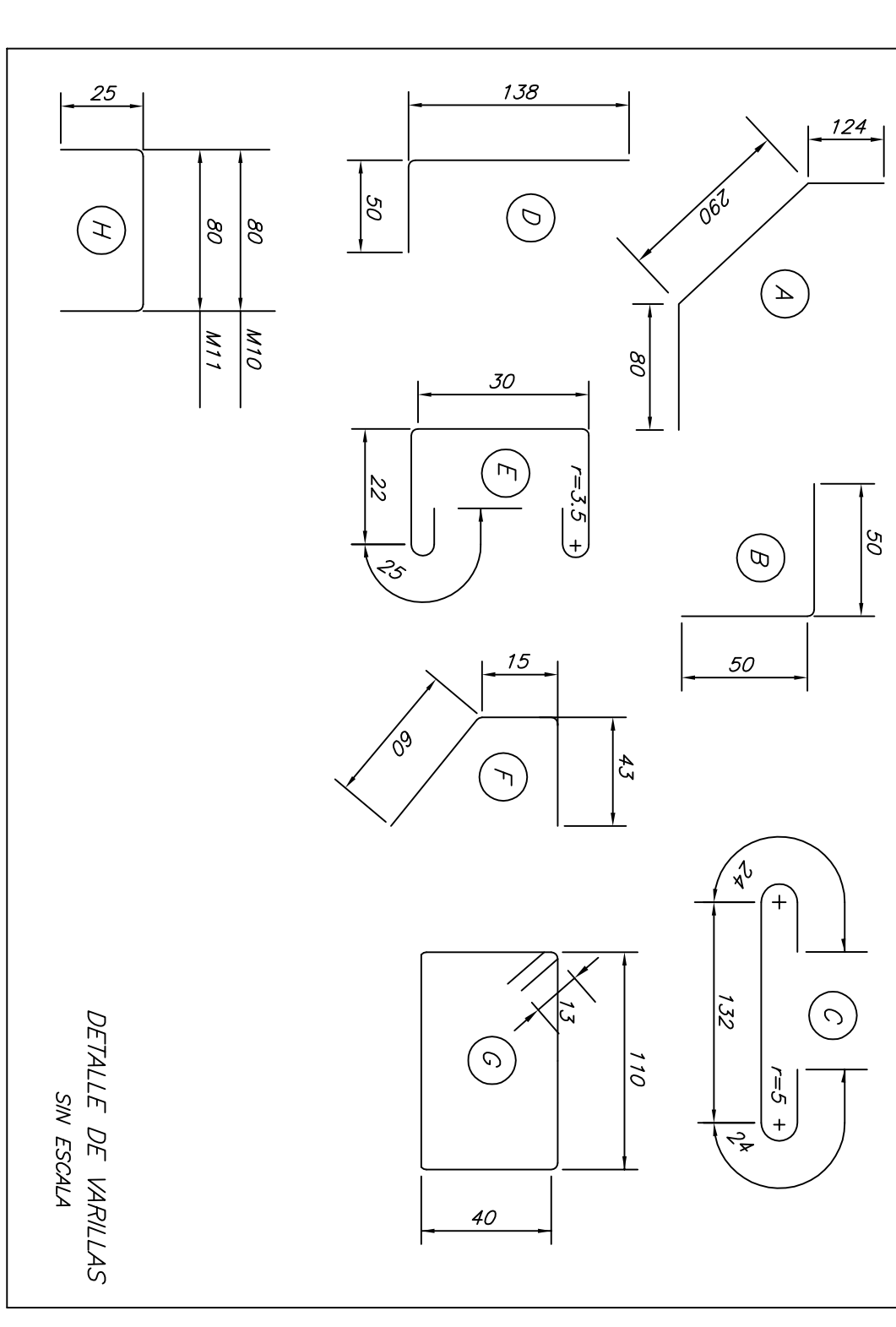